

With Us, You can

HIGH GREEN SAFE

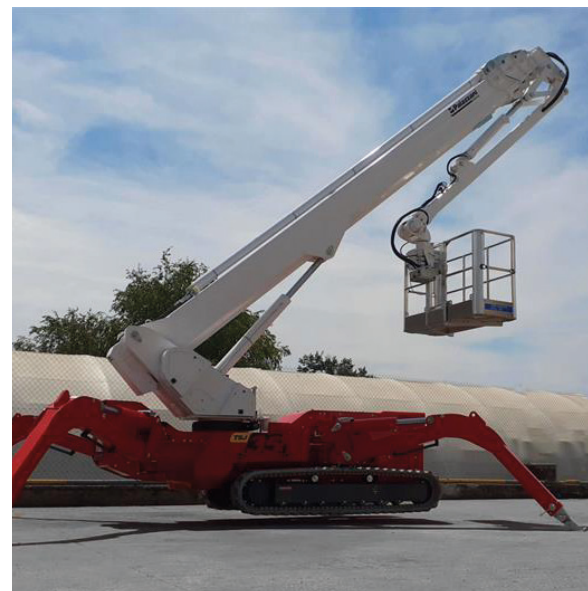

35 m



15 m



230 kg



Bi-energy
Eco

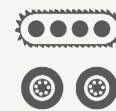

Crawlers
Wheels



SPIDER LIFT



STANDARD EQUIPMENT

- Available power options: Bi-energy (Diesel + AC), Eco (AC+Battery)
- Emergency electropump
- Hydr. steering and transmission on rubber tracks at fixed width
- Independent outriggers rotating on 2 different positions
- Automatic set-up with self-levelling
- Turntable rotation at 660°
- CANBUS electronics
- Steel made telescopic boom with 6 sections + fixed jib
- Removable aluminium alloy aerial cage 180x70x110cm, with hydraulic rotation 90° + 80°
- "Area manager" limiting device for safe working load 120 and 230 kg
- Radio control at the ground + electric control at the cage
- 230VAC electric plug on the cage
- Air \ water supplementary line
- Inter-phonic communication system
- PalSystem with touchscreen monitor for diagnostics and monitoring of operating parameters
- CE Mark homologation certificates, manuals, stickers and spares book in English language



OPTIONAL



HYDRAULIC WINCH 500 KG

The winch, replacing the basket, allows to transform the Spider lift in Spider crane with a maximum lifting capacity of 500 kg. It is supplied with a special mobile support for the basket disassembled.

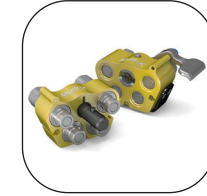

QUICK PIPES COUPLING KIT FOR HYDRAULIC WINCH 500 KG

Coupling system and quick release of the hydraulic winch to accelerate and speed up the replacement between basket and winch, reducing significantly the machine downtime.

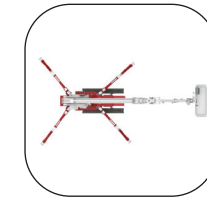

EXTENDABLE OUTRIGGERS

To improve the maximum slope and to allow self-loading on trucks.

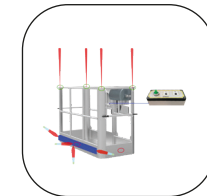

BASKET ANTI-COLLISION KIT

The laser sensors are positioned at the four corners of the basket and monitor the distance between the operator and any vertical obstacles. Ultrasonic sensors check the presence of any obstacles around the perimeter.



NON-MARKING TRACKS

white rubber, ideal to operate indoor and/ or on delicate floors



PEDAL TO THE CAGE

Safety pedal to operate the movements from the cage.



TOUCHSCREEN MONITOR IN THE CAGE

Installed on the cage control panel, providing the operator with all detailed and salient information of the aerial working platform he needs during aerial work.

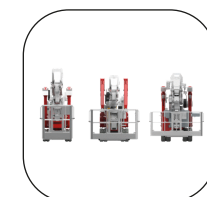

CAGES OF DIFFERENT SIZES

Different sizes aluminium cages for one man, or majored to accommodate more people or bulky equipment.



KIT PALCONNECT

Remote connection service with the aerial platform that allows the user to monitor the key parameters of use of the machine and intervene with some of them.



LED LIGHT

One or more additional led headlights installed on the basket or on the boom.



CUSTOMIZED COLOURS

Possibility to customize the colours of the tracked lift with different RAL according to the client's corporate livery

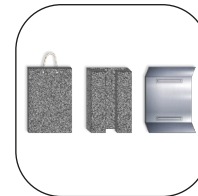

PADS FOR OUTRIGGERS

Different type of pads to distribute the load of the stabilizers on the ground and have greater stability of the machine.



RETURN TO HOME FUNCTION

The "return to home" function allows to automatically return to the transport position by pressing a button on the controls.



ELECTRIC GENERATOR

230VCA single-phase, powered by the diesel engine, connected to an electrical socket in the cage, for the use of electrical tools during aerial working



CASTORS UNDER THE CAGE

4 wheels mounted under the basket for easily moving it when dismounted.



ANEMOMETER

device for measuring the wind, with an acoustic warning of the wind max speed allowed for aerial working



BI-ENERGY



Diesel
18,2 kW



Single-phase
Electric motor
230VAC - 3 kW

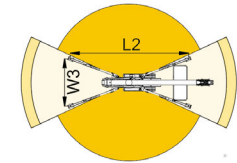
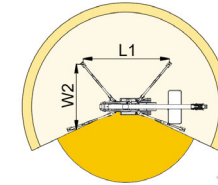
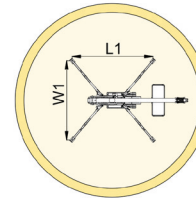
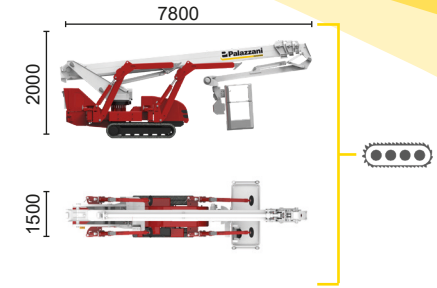
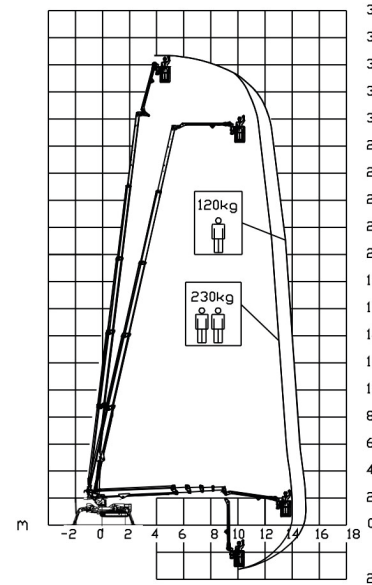
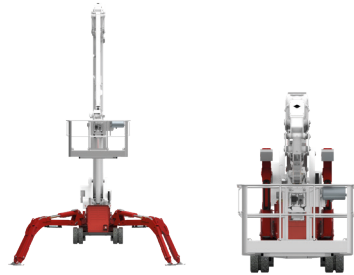

14 m	15 m	8,5 m	L1	L2	W1	W2	W3
230 kg	120 kg	230/120 kg	5535 mm	7160 mm	5260 mm	3975 mm	2680 mm



TSJ 35.1/C 35 m 15 m 230 kg 660° 180x70 cm 90°+80° 2,68-5,26 m 23% 36% 1,8 km/h 7100 kg 47 kN 2,44 kN/m² 5,06 kN/m²

Available version:

BI-ENERGY (DIESEL+AC)

ECO (AC+BATTERY)

Characteristics and technical data are informative only and subjected to change without notice.

Palazzani Industrie S.p.A.

Via del Pavione, 4 - 25050 - Paderno F.C. (BS) - Italy

Tel. (+39) 0306857073

info@palazzani.it

www.palazzani.it





BI-ENERGY



Diesel
18,2 kW



Single-phase
Electric motor
230VAC - 3 kW

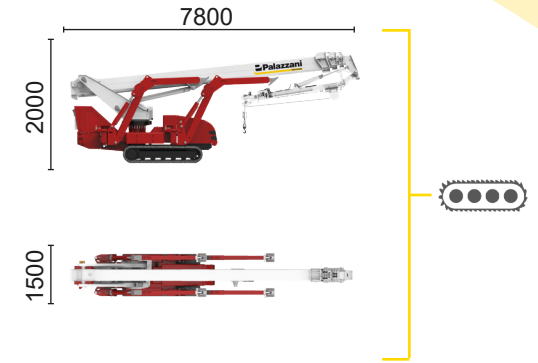
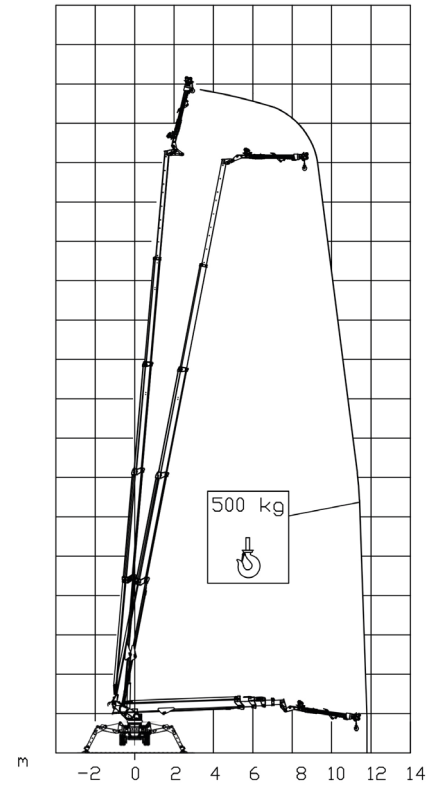

TSJ 35.1/C  33,7 m 11,8 m 500 kg 660° 180x70 cm 90°+80° 2,68-5,26 m 23% 36% 1,8 km/h 7100 kg 47 kN 2,44 kN/m² 5,06 kN/m²

Available version:

BI-ENERGY (DIESEL+AC)

ECO (AC+BATTERY)

Characteristics and technical data are informative only and subjected to change without notice.

Palazzani Industrie S.p.A.

Via del Pavione, 4 - 25050 - Paderno F.C. (BS) - Italy

Tel. (+39) 0306857073

info@palazzani.it

www.palazzani.it





ECO

Single-phase
Electric motor
230 VAC - 16 kW

Lithium iron
phosphate battery
LiFePO4
48 V - 330 Ah

Type 2 plug charge

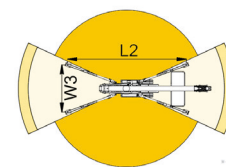
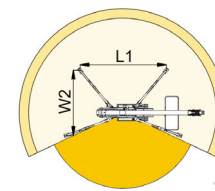
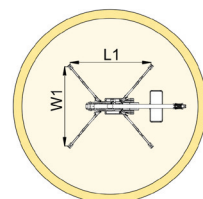
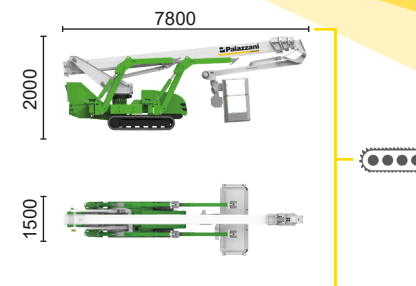
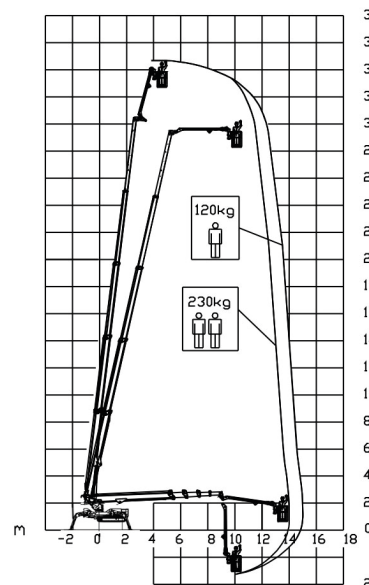
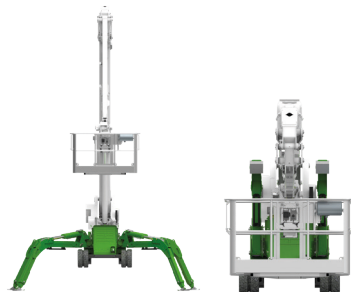

14 m	15 m	8,5 m	L1	L2	W1	W2	W3
230 kg	120 kg	230/120 kg	5535 mm	7160 mm	5260 mm	3975 mm	2680 mm



TSJ 35.1/C 35 m 15 m 230 kg 660° 180x70 cm 90°+80° 2,68-5,26 m 23% 36% 1,8 km/h 7100 kg 47 kN 2,44 kN/m2 5,06 kN/m2

Available version:

BI-ENERGY (DIESEL+AC)

ECO (AC+BATTERY)

Characteristics and technical data are informative only and subjected to change without notice.

Palazzani Industrie S.p.A.

Via del Pavione, 4 - 25050 - Paderno F.C. (BS) - Italy

Tel. (+39) 0306857073

info@palazzani.it

www.palazzani.it





ECO

- Single-phase Electric motor
230 VAC - 16 kW
- Lithium iron phosphate battery
LiFePO4
48 V - 330 Ah
- Type 2 plug charge

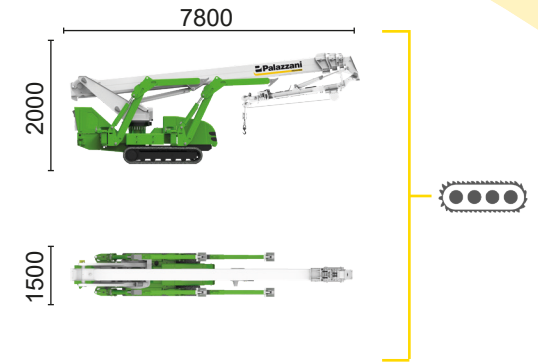
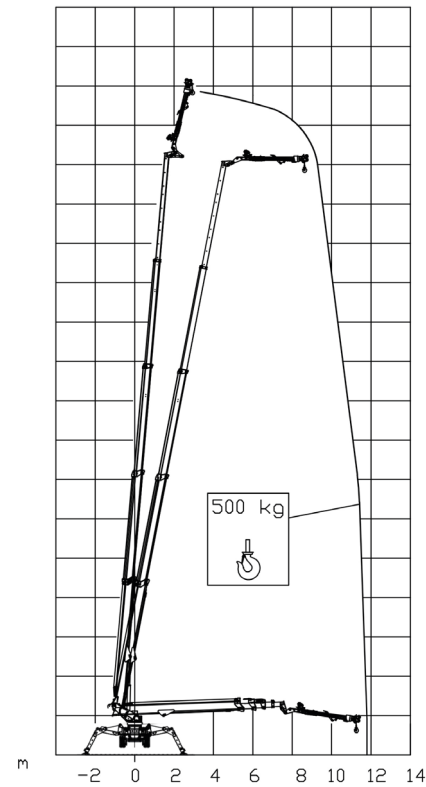

TSJ 35.1/C		33,7 m	11,8 m	500 kg	660°	180x70 cm	90°+80°	2,68-5,26 m	23%	36%	1,8 km/h	7100 kg	47 kN	2,44 kN/m ²	5,06 kN/m ²
------------	--	--------	--------	--------	------	-----------	---------	-------------	-----	-----	----------	---------	-------	------------------------	------------------------

Available version:

BI-ENERGY (DIESEL+AC)

ECO (AC+BATTERY)

Characteristics and technical data are informative only and subjected to change without notice.

Palazzani Industrie S.p.A.

Via del Pavione, 4 - 25050 - Paderno F.C. (BS) - Italy

Tel. (+39) 0306857073

info@palazzani.it

www.palazzani.it

