

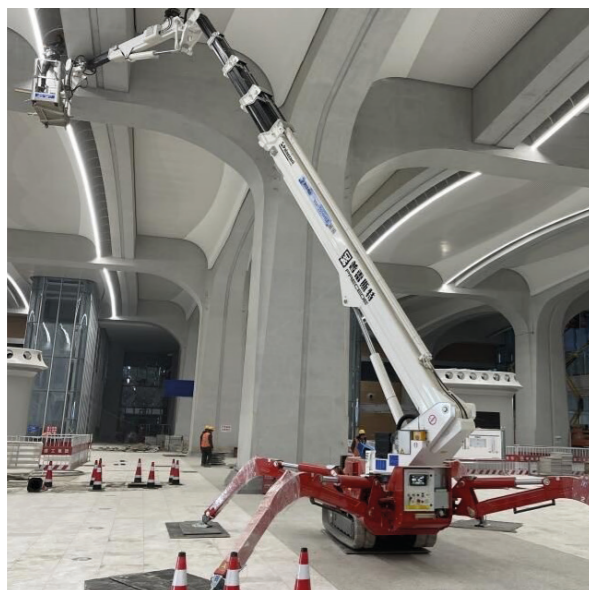





With Us, You can

**HIGH
GREEN
SAFE**



- 
43 m
- 
18 m
- 
330 kg*
*optional
- 
**Bi-energy
Eco**
- 
Crawlers
- 
Wheels





STANDARD EQUIPMENT

- Available power options: Bi-energy (Diesel + AC), Eco (AC+Battery)
- Emergency electropump
- Pistons hydraulic pump at variable displacement for fast and sharp movements and consumption savings. CANBUS distributor + CANBUS electronics
- "Return to home" function
- Hydr. steering and transmission on rubber tracks with hydraulically variable external width
- Independent outriggers rotating on 2 different positions
- Automatic set-up with self-levelling
- Turntable rotation at 660°
- Steel made telescopic boom + telescopic jib
- Removable aluminium alloy aerial cage 240x70x110cm, with hydraulic rotation 90° + 80°
- "Area manager" limiting device for safe working load 120 and 230 kg
- Radio control at the ground + electric control at the cage
- 230VAC electric plug on the cage
- Air \ water supplementary line
- Inter-phonic communication system
- PalSystem with touchscreen monitor for diagnostics and monitoring of operating parameters
- CE Mark homologation certificates, manuals, stickers and spares book in English language



HYDRAULIC WINCH 500 KG

The winch, replacing the basket, allows to transform the Spider lift in Spider crane with a maximum lifting capacity of 500 kg. It is supplied with a special mobile support for the basket disassembled.

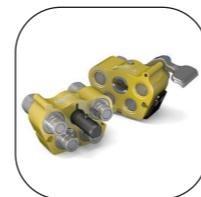

QUICK PIPES COUPLING KIT FOR HYDRAULIC WINCH 500 KG

Coupling system and quick release of the hydraulic winch to accelerate and speed up the replacement between basket and winch, reducing significantly the machine downtime.



PROTECTION OF PRUNERS

Covers kit in iron for delicate parts of the machine such as cylinders stems, valves and reels to protect against branches or other materials falling from above.

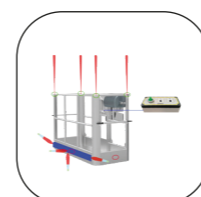

BASKET ANTI-COLLISION KIT

The laser sensors are positioned at the four corners of the basket and monitor the distance between the operator and any vertical obstacles. Ultrasonic sensors check the presence of any obstacles around the perimeter.



NON-MARKING TRACKS

white rubber, ideal to operate indoor and/ or on delicate floors



PEDAL TO THE CAGE

Safety pedal to operate the movements from the cage.



CASTORS UNDER THE CAGE

4 wheels mounted under the basket for easily moving it when dismounted.



TOUCHSCREEN MONITOR IN THE CAGE

Installed on the cage control panel, providing the operator with all detailed and salient information of the aerial working platform he needs during aerial work.



KIT PALCONNECT

Remote connection service with the aerial platform that allows the user to monitor the key parameters of use of the machine and intervene with some of them.



3rd WORKING AREA

Work area with an increased load, to have the possibility to work with 330 kg of load in the basket



CUSTOMIZED COLOURS

Possibility to customize the colours of the tracked lift with different RAL according to the client's corporate livery



PADS FOR OUTRIGGERS

Different type of pads to distribute the load of the stabilizers on the ground and have greater stability of the machine.



ELECTRIC GENERATOR

230VCA single-phase, powered by the diesel engine, connected to an electrical socket in the cage, for the use of electrical tools during aerial working



ANEMOMETER

device for measuring the wind, with an acoustic warning of the wind max speed allowed for aerial working

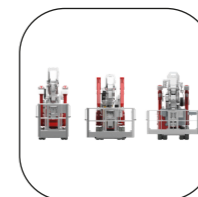

CAGES OF DIFFERENT SIZES

Different sizes aluminium cages for one man, or majored to accommodate more people or bulky equipment.



LED LIGHT

One or more additional led headlights installed on the basket or on the boom.



BI-ENERGY

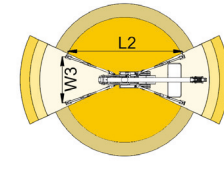
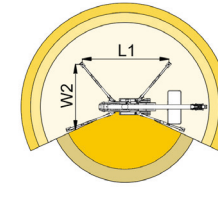
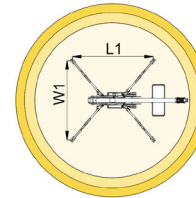
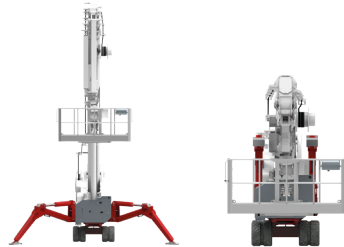
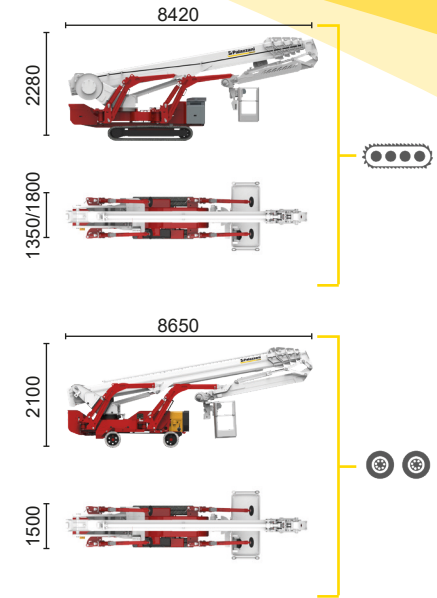
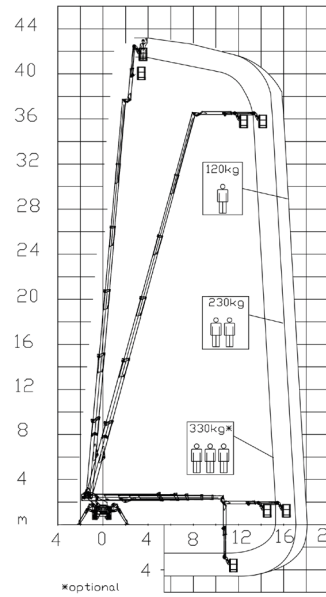

 Diesel
32,5 kW

 Single-phase
Electric motor
230VAC - 2,2 kW



15,2 m	17 m	18 m	11,8 m	13,5 m	L1	L2	W1	W2	W3
330* kg	230 kg	120 kg	330* kg	120/230 kg	5945 mm	7095 mm	5230 mm	4435 mm	3640 mm



XTJ 43+/C		43 m	18 m	330 kg*	660°	240x70 cm	90°+80°	3,64-5,23 m	23%	38%	2 km/h	10900 kg	75 kN	3,51 kN/m ²	5,39 kN/m ²
XTJ 43+/R		43 m	18 m	330 kg*	660°	240x70 cm	90°+80°	3,64-5,23 m	23%	16%	1,4 km/h	10900 kg	75 kN	3,51 kN/m ²	5,25 kN/m ²

Available power options:

BI-ENERGY (DIESEL+AC)

ECO (AC+BATTERY)

Characteristics and technical data are informative only and subjected to change without notice.

Palazzani Industrie S.p.A.

Via del Pavione, 4 - 25050 - Paderno F.C. (BS) - Italy

Tel. (+39) 0306857073

info@palazzani.it

www.palazzani.it



NC 842 A 22



BI-ENERGY

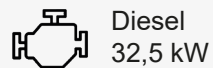

Diesel
32,5 kW



Single-phase
Electric motor
230VAC - 2,2 kW

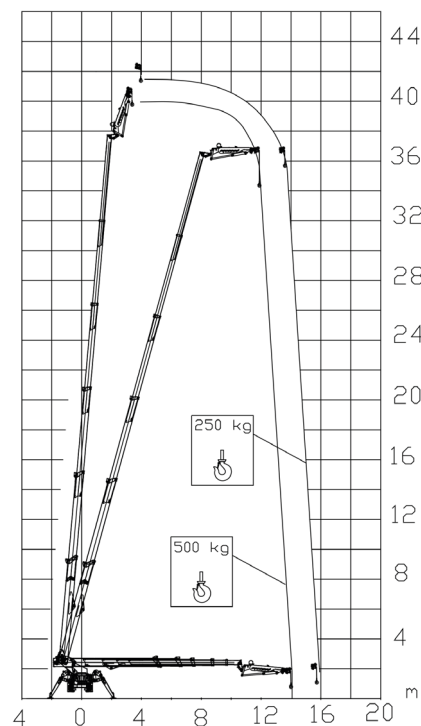

500 kg	250 kg
13,5 m	15,2 m

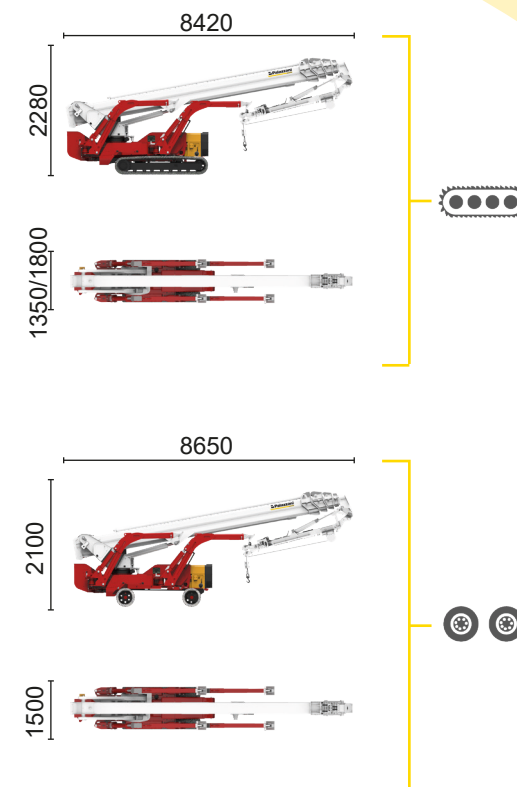

XTJ 43+/C		41,7 m	15,2 m	500 kg	660°	240x70 cm	90°+80°	3,64-5,23 m	23%	38%	2 km/h	10900 kg	75 kN	3,51 kN/m ²	5,39 kN/m ²
XTJ 43+/R		41,7 m	15,2 m	500 kg	660°	240x70 cm	90°+80°	3,64-5,23 m	23%	16%	1,4 km/h	10900 kg	75 kN	3,51 kN/m ²	5,25 kN/m ²

Available power options:

BI-ENERGY (DIESEL+AC)

ECO (AC+BATTERY)

Characteristics and technical data are informative only and subjected to change without notice.

Palazzani Industrie S.p.A.

Via del Pavione, 4 - 25050 - Paderno F.C. (BS) - Italy

Tel. (+39) 0306857073

info@palazzani.it

www.palazzani.it





ECO

 Single-phase
Electric motor

 Lithium iron
phosphate battery
LiFePO4

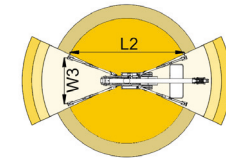
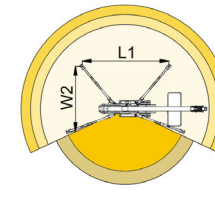
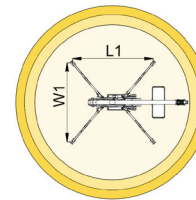
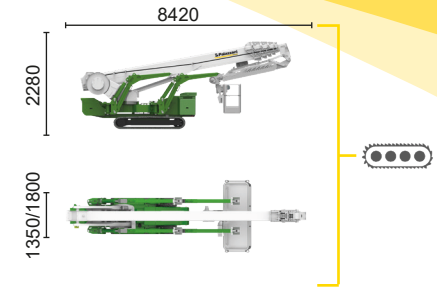
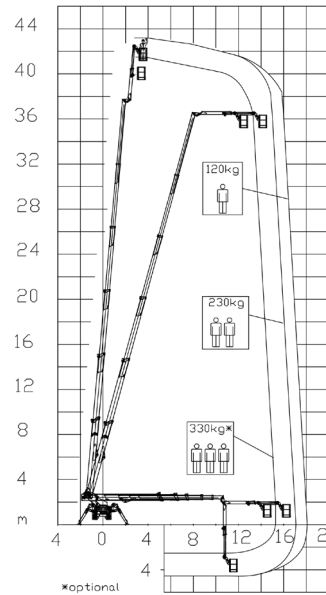

15,2 m	17 m	18 m	11,8 m	13,5 m	L1	L2	W1	W2	W3
330* kg	230 kg	120 kg	330* kg	120/230 kg	5945 mm	7095 mm	5230 mm	4435 mm	3640 mm



XTJ 43+/C		43 m	18 m	330 kg*	660°	240x70 cm	90°+80°	3,64-5,23 m	23%	38%	2 km/h	10900 kg	75 kN	3,51 kN/m2	5,39 kN/m2
-----------	---	------	------	---------	------	-----------	---------	-------------	-----	-----	--------	----------	-------	------------	------------

Available power options:

BI-ENERGY (DIESEL+AC)

ECO (AC+BATTERY)

Characteristics and technical data are informative only and subjected to change without notice.

Palazzani Industrie S.p.A.

Via del Pavione, 4 - 25050 - Paderno F.C. (BS) - Italy

Tel. (+39) 0306857073

info@palazzani.it

www.palazzani.it



NC 844 A 22



ECO





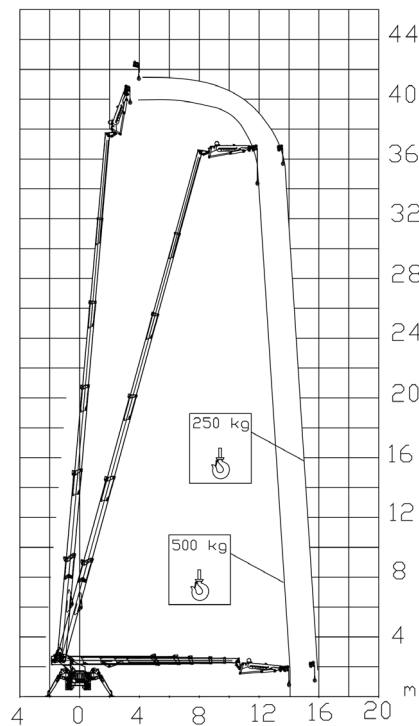



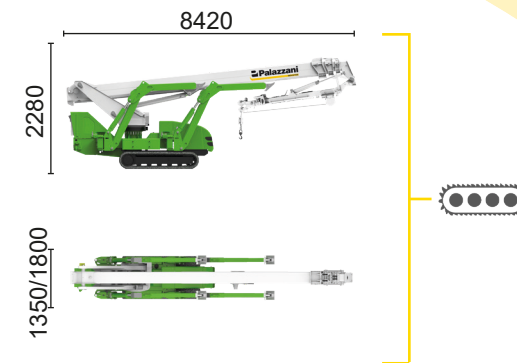







 Single-phase Electric motor

 Lithium iron phosphate battery LiFePO4



500 kg	250 kg
13,5 m	15,2 m



XTJ 43+/C																
		41,4 m	15,2 m	500 kg	660°	240x70 cm	90°+80°	3,64-5,23 m	23%	38%	2 km/h	10900 kg	75 kN	3,51 kN/m ²	5,39 kN/m ²	

90°+80°

Available power options:

BI-ENERGY (DIESEL+AC)

ECO (AC+BATTERY)

Characteristics and technical data are informative only and subjected to change without notice.

Palazzani Industrie S.p.A.

Via del Pavione, 4 - 25050 - Paderno F.C. (BS) - Italy

Tel. (+39) 0306857073

info@palazzani.it

www.palazzani.it

